

Nexans Managed Industrial Ethernet Switches

Technical Documentation

Version 2.4, November 2021



iGigaSwitch 1002 E+ SFP-2VI

iGigaSwitch 1004 E+ SFP-4VI

iGigaSwitch 1008 E+ SFP-8VI

FOREWORD

LANactive Industry solution, which offers products designed for mission critical applications, is based on over 30 years of Nexans experience in developing and producing managed industrial and FTTO switches for harsh environment applications. Industrial switches and accessories form the core of our solution offering. LANmark Industry copper and fibre cabling has been developed to meet the high standards, transmission demands and environmental requirements of mission critical applications.

We also provide easy and intuitive solutions, based on a LANactive Manager software platform, for centralized configuration and management of large networks. Thousands of switches may be operated by a single employee.

Our integrated offering is rounded off with a wide range of support and training services, with access to a global expert and service network through a single point of contact.

Purpose of the manual

This manual describes the features, functions, operation and commissioning of the following devices of the GigaSwitch series:

- iGigaSwitch 1002 E+ SFP-2VI
- iGigaSwitch 1004 E+ SFP-4VI
- iGigaSwitch 1008 E+ SFP-8VI

Target group

Planners and installers of Industry solutions, electrical engineers, persons entrusted with setting, testing and maintaining Industry switches

Scope of the manual

This manual is valid for the Nexans iGigaSwitch series 10xx in combination with the current V5 version of the Nexans LANactive Manager to manage switches with Management Hardware HW5.

The User Manual may include more than one product. Part of the content, e.g. some use cases or specifications, may only apply to some of them. For more information on the exact feature set and specifications, see the product's web page and datasheet.

Support

If you are not yet a registered user of the Nexans Support Portal, please register at the Nexans support portal <http://www.nexans-ans.de/support/> and download the latest version of the firmware and the management tool. Here you will also find the related V5 release notes and the current versions of V5 management manual.

If you have any questions or problems, please contact us at the following support e-mail address:

support.ans@nexans.com

To benefit from individualized and extended product support, we recommend concluding a Nexans support contract. If you are interested, please send us your request by e-mail to sales.ans@nexans.com

EC DECLARATION OF CONFORMITY

The manufacturer

Nexans Advanced Networking Solutions GmbH
Bonnenbroicher Strasse 2-14
41238 Moenchengladbach
Germany

declares under its sole responsibility that the products:

- **88306422 iGigaSwitch 1002 E+ SFP-2VI**
- **88306424 iGigaSwitch 1004 E+ SFP-4VI**
- **88306428 iGigaSwitch 1008 E+ SFP-8VI**

- **88301602 iOption PoE+ 2/4P-30W**
- **88301604 iOption PoE+ 6/8P-30W**
- **88301664 iOption PoE++ 2/4P-90W**
- **88301666 iOption PoE++ 6/8P-90W**

- **88300692 SD Memory Card with MAC-Address**

Following the provisions of directives:

- **2014/30/EU Electromagnetic Compatibility Directive**
- **2011/65/EU RoHS**

to which this declaration relates are in conformity with the following directives and standards:

- **EN 62368-1:2014:** Audio/video, information and communication technology equipment - Part 1: Safety requirements
- **EN 55032:2012:** Electromagnetic compatibility of multimedia equipment - Emission requirements
- **EN 61000-6-2:2005:** Electromagnetic compatibility (EMC) - Part 6-2: Generic standards - Immunity standard for industrial environments
- **EN 50581:2012:** Technical documentation for the assessment of electrical and electronic products with respect to the restriction of hazardous substances

The quality and environmental management system of Nexans Advanced Networking Solutions GmbH according to DIN EN ISO 9001:2000 and DIN EN ISO 14001:2005 ensures compliance with the European Directives and the fulfilment of the relevant standards of the European standards bodies CEN, CENELEC and ETSI.

INDUSTRIAL ETHERNET SWITCHES

Any application in which an infrastructure failure could result in serious damage or life-threatening situations may be considered mission critical. Mission critical applications are not limited to transport, traffic monitoring, oil & gas, Smart Grids, electrical substations, or wind turbines, but might also include IP video surveillance and security in cities or on campuses.

Network infrastructure in these applications must operate under the harshest conditions. Performance can be affected by, for example, extreme temperatures, chemicals, ingress, interference, vibration or moisture. However, the infrastructure should have no failures or downtime, as this could result in severe damage or even loss of life. That's why infrastructure and components for mission critical applications need to meet far higher requirements than a standard network for offices.

Design must be compact and robust, equipment should offer high redundancy in areas such as data transmission and power and guarantee high levels of availability and security. Compliance with specific industry standards is vital, as are advanced solutions for ongoing monitoring. Many 'non-traditional' devices are currently being connected to networks and these need to be monitored and managed by SCADAs. As large areas are covered, the network must be managed and maintained in a smarter way than ever before, using a centralized approach.

Nexans LANactive Industry solution is based on Industrial Ethernet switches, industrial cabling, software and services and designed for creating reliable and highly available LAN infrastructures in harsh environments of mission critical applications.

Nexans industrial Ethernet switches are targeted to provide highest network availability, security and to make network maintenance much easier. They have a high level of interoperability with other switches manufacturers and different SCADAs. The switches provide high flexibility in network design – depending on the model, they can have up to 16 ports: fibre-optic or copper in different combinations, including the variant with 12x SFP and 4x RJ45 ports.

iGigaSwitch family can power many devices with PoE or PoE+ technology: has up to 12x PoE+ ports with 360W budget according to IEEE 802.3at.

Fast, simple and low-cost integration of additional non-Ethernet devices directly in the field is possible with optional I/O interfaces of industrial Ethernet switches.



TABLE OF CONTENTS

Foreword.....	1
EC Declaration of Conformity.....	3
Industrial Ethernet Switches.....	4
Table of Contents.....	5
Application/Description.....	6
Technical Data	8
Dimensions	10
DIN-Rail Installation	11
Switch Connector Overview	12
Product Labels	13
Safety Instructions and Disclaimer	14
Preparation for Operation.....	15
Pin Assignment	16
Grounding	17
Power over Ethernet (optional)	18
Power Supplies	20
Product Overview - Power Supplies.....	23
Transmission Parameters	24
Memory Cards and Console Cables	25
I/O Module	26
LED Indicators	28
Start-up – Booting	29
Configuration Mode.....	30
Port Status LEDs.....	31
LANactive Manager Description.....	32
Firmware Features	34
Product List	35
Support Portal	40
LANactive Starter Kits	41
Frequently Asked Questions (FAQ)	44
Abbreviations	46

APPLICATION/DESCRIPTION

LANactive 10 port managed Industrial Ethernet Switches

- 10x Gigabit ports switches family with different number of SFP ports: 8, 4 or 2
- Up to 8x PoE/PoE+ ports with 240W power budget according to IEEE 802.3at
- Wide functionality targeted to make a network maintenance easier
- IEC 61850 compliancy is tested and certified by KEMA/DNV-GL
- Wide operating temperature range: -40 ... +85°C

Description

Nexans managed Industrial Ethernet switches of iGigaSwitch 10xx E+ family are the core of LANactive Industry solution and are designed for building robust and reliable network in harsh environment of many mission critical applications.

LANactive Industry solution includes:

- managed Industrial Ethernet switches and its accessories
- wide copper and fibre cabling offer including their industrial variant
- configuration and management software for the switches
- support services

Nexans iGigaSwitch 10xx E+ family is designed to provide maximum network availability, security, longest lifetime in harsh environments and making a network maintenance easier.

iGigaSwitch 10xx E+ family provides great flexibility in network design - it has up to 10x Gigabit ports in different combination. The iGigaSwitch allows to adapt the interfaces to the application by using the corresponding pluggable modules (Fast Ethernet or Gigabit SFP). There are different models available: with 8x, 4x and 2x SFP ports.

I/O interfaces

The preinstalled I/O module of the iGigaSwitch 10xx E+ family has two potential-free function inputs and two programmable alarm contacts for fast, simple and low-cost integration of additional non-Ethernet devices.

Power over Ethernet (PoE/PoE+)

Up to 8x connected devices can be supplied with Power over Ethernet. In accordance with the latest IEEE 802.3at (PoE+) standard, up to 30 Watts of power are available for each connected device, with total budget of 240Watts.

There are two PoE/PoE+ options available for iGigaSwitch 10xx E+ family depending on the switch model - for 4x or 8x (88301602 or 88301604 respectively).

IEC 61850

Nexans iGigaSwitch family comply to IEC 61850 requirements (parts 6, 7-1, 7-2, 7-3, 7-4, 8-1, 9-1 and 9-2 Communication networks and systems for power utility automation). This functionality is critical for Smart grid and allows to use standardized equipment to ensure correct and reliable communication of all networked devices of Smart grid infrastructure (including switches, PLCs, different controllers, sensors etc.) with each other and with central SCADA.

The compliance is tested and confirmed by KEMA/DNV-GL.

Easy maintenance

There is an extensive range of Industrial Ethernet switch functionalities to make the network maintenance much easier. In many cases, network infrastructures are scattered over wide areas - Smart grid, industrial of infrastructures sites, oil & gas application, IP video surveillance and security systems in campuses or cities, etc.

- Nexans switches have an extensive diagnostic functionality to provide a wide range of information about their condition, temperature, power level, ports usage, PoE and many others. Alerts can be defined for many parameters to automate IT maintenance processes.

- The cable diagnostic function of Nexans industrial switches (will be available with next firmware) ensures an easy and fast localisation of possible faults on the connected Twisted Pair copper cables. An identification of short circuits, interruptions, impedance mismatches or reversals can be localised up to the meter via the management feature.
- By using SFP modules with Digital Diagnostic Monitoring Function in our Nexans iSwitch systems you can monitor the optical parameters (optical input power, optical output power, laser bias current) and to recognize upcoming problems with the fibre optic link at an early stage!
- SD cards with unique MAC address – this option makes network maintenance easier by simplifying several processes like switches setup and replacement. This option will help to utilize the IT staff resources smarter and more efficient.
- LANactive Manager (Nexans switch configuration and management platform) is an easy-to-use intuitive and efficient solution to supervise, manage and configure for Nexans switches
- Other functionalities

Interoperability

Nexans Industrial Ethernet switches offers tested and approved interoperability, including its proprietary protocols, with a wide range of manufacturers, including Cisco, HP, Alcatel Lucent (Nokia), Extreme Networks, etc.

In addition, Nexans Industrial Ethernet switches:

- support CDP (Cisco Discovery Protocol) and LLDP protocols
- are compatible with Cisco Secure Access Control Server ACS

Nexans iGigaSwitch family can operate in various SCADAs.

Management

- WEB/SNMP/SSH/V.24 management
- Enhanced security features by providing controlled access to the management data through different authentication levels, port security and encrypted communication (SCP, SSHv2, HTTPS, RADIUS, SNMPv3, IEEE 802.1X etc.)
- Integration to any SNMP based management platform
- Easy configuration of large number of switches via LANactive Manager (administration tool)
- IPv6 according to IPv6 Forum phase 2 core specifications

TECHNICAL DATA

Ordering information	iGigaSwitch 1002 E+ SFP-2VI HW5	iGigaSwitch 1004 E+ SFP-4VI HW5	iGigaSwitch 1008 E+ SFP-8VI HW5
Article number	88306422	88306424	88306428
LAN interfaces			
User interfaces (Twisted Pair)	8x 1000Base-T	6x 1000Base-T	2x 1000Base-T
Uplink interfaces (SFP)	2x 100/1000 Mbps	4x 100/1000 Mbps	8x 100/1000 Mbps
HSR/PRP interfaces (SFP)		-	
Diagnostic functions (interfaces)			
Digital Diagnostics Monitoring Interface		Yes	
Twisted Pair cable diagnostic		Yes	
General			
Dimensions [WxHxD]	83mm x 133mm x 125mm		
IP protection class	IP30 (EN 60529)		
Mounting	35mm DIN-Rail Mounting according to EN 60715, (EN 50022) Different mounting positions of DIN-rail clip - vertical and horizontal switch mounting. Optional: wall mounting.		
Material	anodised/varnished aluminium		
Colour	black		
Ambient temperature	Operation: -40 ... 85°C, Storage: -40 ... 85°C		
Relative humidity	20 - 90% (non-condensing)		
Weight	1300g		
MTBF	> 500.000h		
Power Supply			
Input voltage for switch	18 ... 60V DC		
Input voltage for PoE+	46...57 V DC (typ. 54V DC)		
Power consumption (without PoE)	13W (standby)...15W (typ.) ... 22W (fully connected)		
Heat output	51.15 BTU(IT)/h (typ.)		
Connector	5-pin terminal blocks, screw-on type (up to 2.5 mm ²) / (+) (-) (+) (-) (FPE)		
Connector PoE	3-pin terminal blocks, screw-on type (up to 2.5 mm ²) / (+) (-) (FPE)		
Power over Ethernet			
Number of PoE+ ports	Max. 8	Max. 6	Max. 2
Max. PoE power budget	Max. 240W	Max. 180W	Max. 60W
Number of PoE++ ports	-	Max. 6	-
Max. PoE++ power budget	-	Max. 540W	-
Functional parameters			
Switching capacity (backplane)	50Gbps		
Data throughput	> 1,488,000 Packets/sec. per port (FDX, bidirectional)		
Switching mode	Store and forward, self-learning		
Max. frame size	9,600 bytes (Support of Jumbo frames)		
Latency	15µs / 2.5µs (1 Gbps 1518Byte FIFO / LIFO) 2.7µs / 2.2µs (1 Gbps 64Byte FIFO / LIFO)		

Management	On-Board High-Performance management
Hardware	V5, 128 MByte RAM, 16 MByte NOR FLASH, 256 MByte NAND FLASH
Firmware update	Update in separated FLASH domain, corruption impossible
FLASH configuration	Dual configuration, corruption impossible
Configuration button	Yes (optional)
Reset button	Yes (optional)
Memory card	Memory Card with fixed MAC-Address for redundant storage of the complete switch configuration (option)
Console port (V.24)	Yes

Dimensions

Contact
Nexans LAN Systems
Tel.: +49 (0) 2166 27 2220
sales.ans@nexans.com

DIMENSIONS

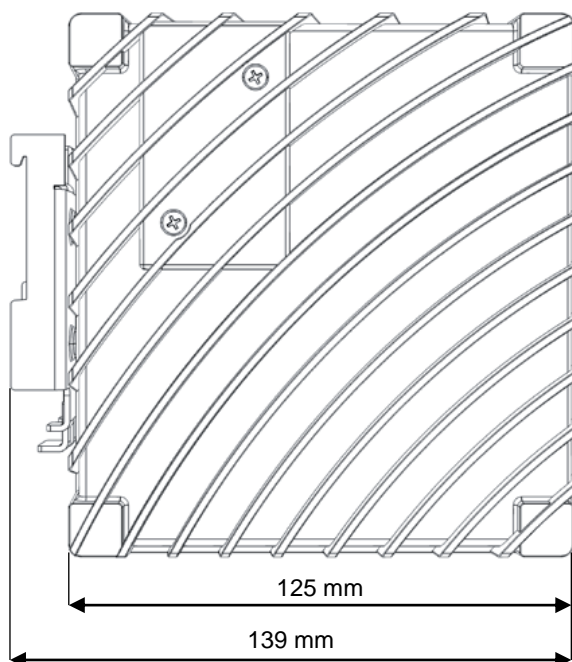
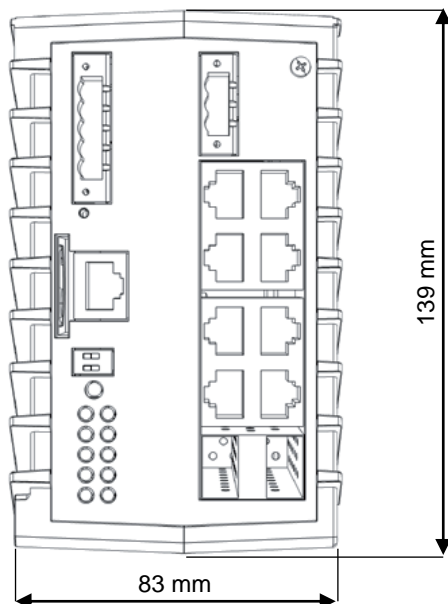

DIN-RAIL INSTALLATION

The DIN rail adapter of 10 ports Industrial Ethernet switch is designed for the installation of a switch on DIN-35mm standard rail. The kit comes with a rail clamp that allows for vertical and horizontal mounting arrangements.

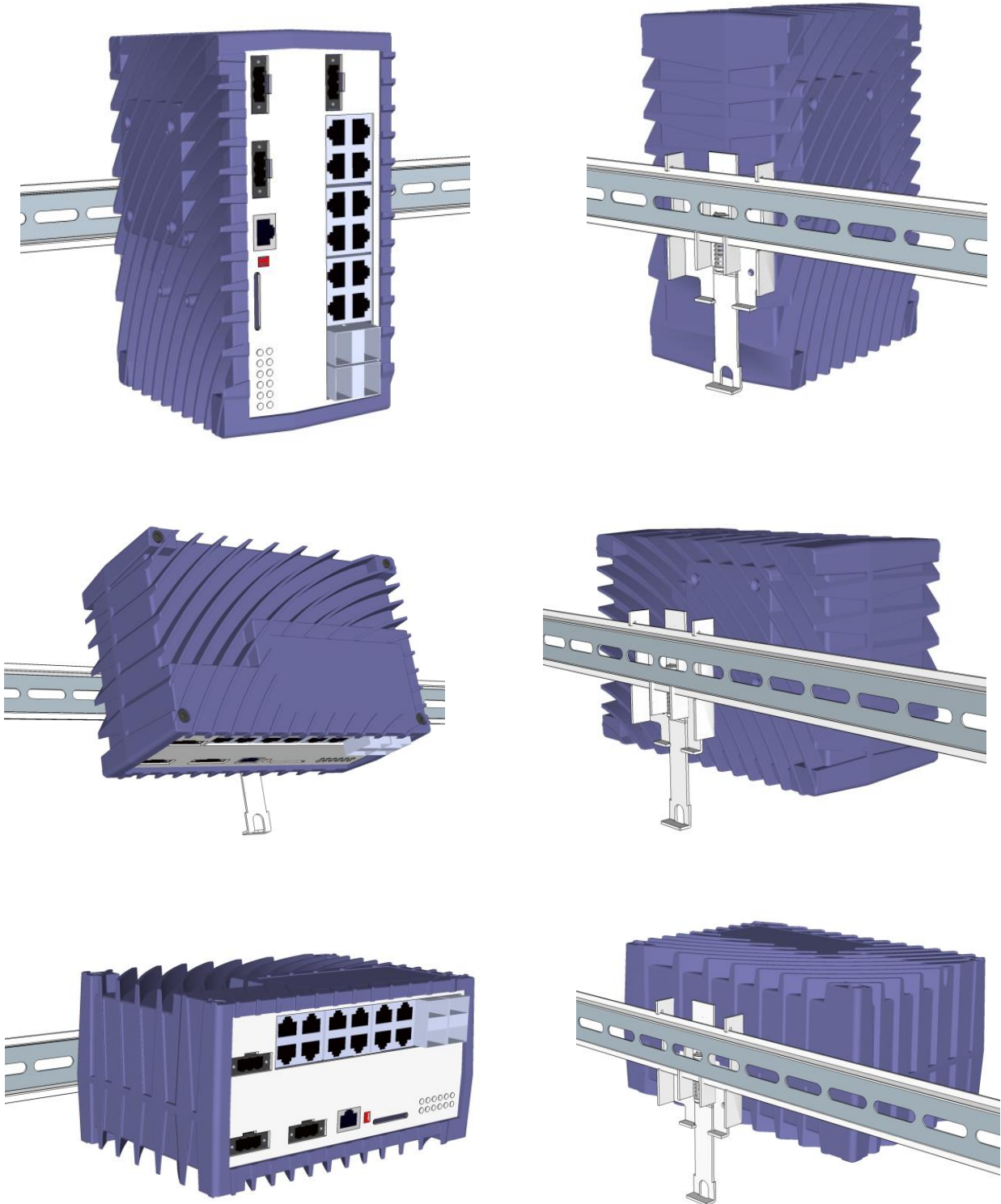

Switch Connector Overview

Contact
Nexans LAN Systems
Tel.: +49 (0) 2166 27 2220
sales.ans@nexans.com

SWITCH CONNECTOR OVERVIEW

iGigaSwitch 10XX HW5 Series

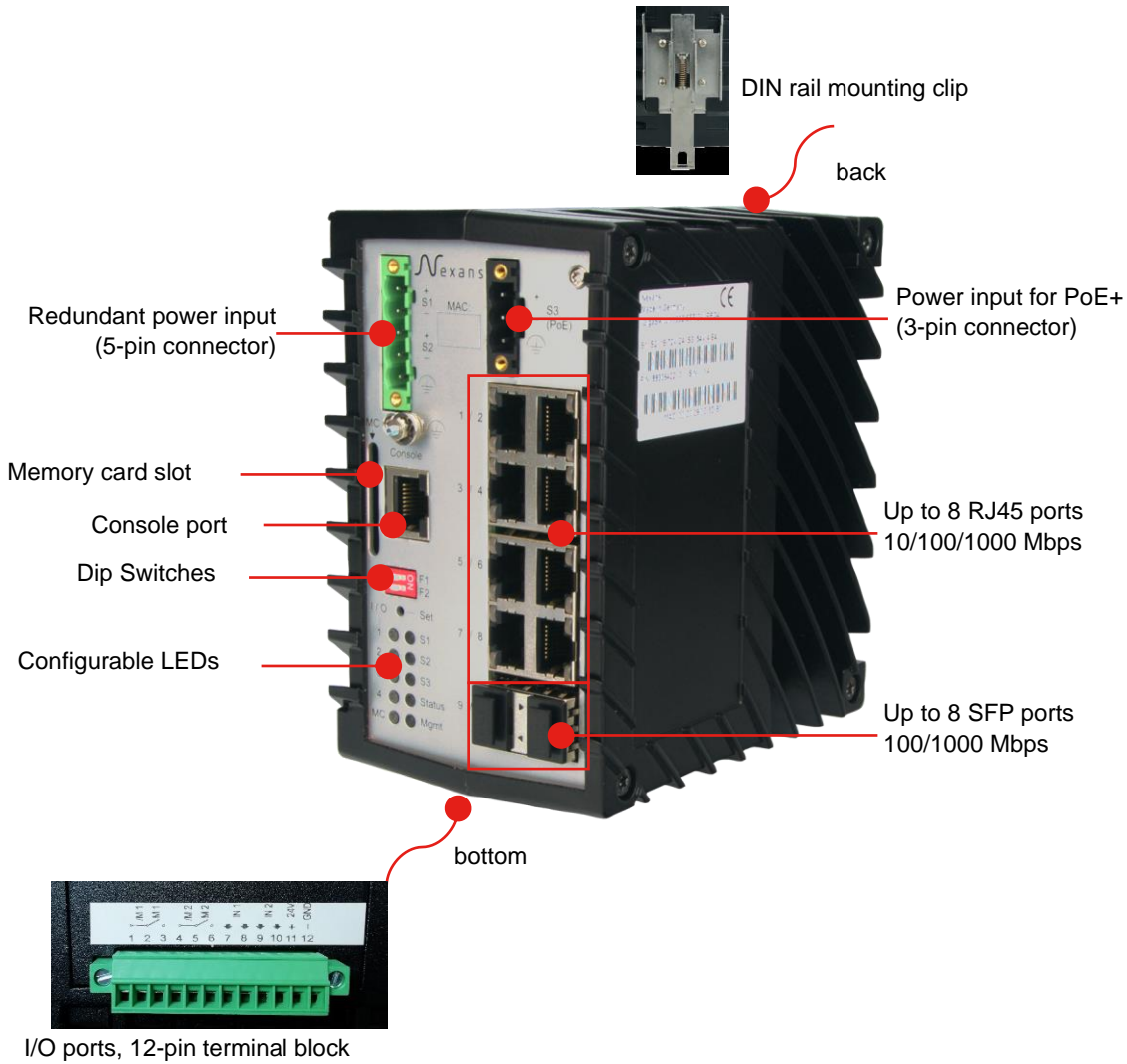

PRODUCT LABELS

The active Nexans devices are equipped with product labels for the purposes of quality assurance and documentation. The product labels contain unique device-specific information that can be used for your project documentation. This information includes MAC address and serial number. The two identity features are unique and can be assigned to each individual device.

The information about the respective MAC address is located twice on the switch. Once on the front of the switch between the power inputs and a second time on the right side of the switch. The sticker on the right side can also be read out when installed.

Use the barcodes of the product label with the MAC address and serial number information to simply read in the device lists using commercially available scanners and document them in tabular form. Associate the MAC address with the information about the installation location and the switch description.



Project Documentation.xlsx - Excel

	A	B	C	D
1	Switch Serial Number	Switch MAC Address	Switch Name	Switch Location
2	201	00C0290C79A0	iGigaSwitch 160C E+	Assembly hall 1
3	202		iGigaSwitch 1608 E+	Assembly hall 2
4	203		iGigaSwitch 1604 E+	Warehouse

Switch List - My project

SAFETY INSTRUCTIONS AND DISCLAIMER

Safety and warning instructions

Only qualified personnel may install and commission the device. Country-specific regulations must be observed.

- Properly perform mains connection and ensure protection against electric shock
- The power supply must be switched from the outside in accordance with the provisions of EN 60950 / EN 62368 (e.g. by the primary-side line protection).
- Sufficiently dimension and secure supply lines
- Dimension secondary-side lines accordingly to the max. output current and secure it separately
- After installation, cover the terminal area to prevent inadmissible touching of live parts (e.g. when installing in metal mounting devices)

Further information can be found at www.nexans.de/LANsystems



ATTENTION: Electrical damage

For device protection, connect a thermomagnetic fuse.



CAUTION: Danger due to electric shock!

Never work with applied voltage.

Disclaimer

The content of this manual has been checked for compliance with the hardware and software described. Nevertheless, deviations cannot be ruled out, so no liability is assumed for the complete agreement. The information in this manual is reviewed regularly and any necessary corrections are included in subsequent editions. Suggestions for improvement are welcomed. Technical changes are reserved, even without notice.

Further information can be found at www.nexans.de/LANsystems

Nexans Advanced Networking Solutions
Bonnenbroicher Str. 2-14
41238 Moenchengladbach
Germany
Tel: +49 2166 27-2220
E-Mail: sales.ans@nexans.com

PREPARATION FOR OPERATION

Opening of the unit

Please disconnect the unit from the mains supply and from all other power sources prior to opening the unit. Any subsequent servicing and repair on the open and live unit may only be performed by a qualified person.

Spare parts

Only original spare parts may be used. Any other spare parts are only allowed if they do not impair the safety of the power supply unit.

Packaging

Do not throw away the packaging. The packaging has been designed for repeated use if not damaged during transport. Only the original packaging can reliably protect the unit from damage during later transport.

Checking the scope of delivery

- Switch Module
- Plug-in screw terminals for connecting the 48 VDC power supply (5-pin)
- Plug-in screw terminals for connecting the PoE power supply (3-pin)
- Documentation
- Management Documentation

Checking for transport damage

Please check the unit for transport damage after unpacking. Transport damage can be assumed in particular if the packaging is visibly damaged. Do not try to operate an obviously damaged unit. This may result in further consequential damages.

Recovery after storage and transport

Moisture can condensate on the unit if the unit has been stored or transported at low temperatures and subsequently taken into a warm room. To avoid any damage please wait till any moisture condensation has vanished from the unit's surface before switching the unit on. The unit is operational only after it has reached the guaranteed operating temperature range (see Technical Data). The same applies also to prior storage at high temperatures.

Cleaning the unit

If the unit has become dirty during use it can be cleaned using a cloth which has been dampened with a mild cleaning agent. Please take care that no cleaning agent enters the interior of the unit.

Power supply

The power supply of the systems is provided via an external power supply (SELV). The system is connected to 48V DC (direct current) via the Power terminal on the rear side using a 5-pin plug-in screw terminal. Protective earth (PE) is connected to one of the provided 6.3 mm FASTON terminals for minimizing leakage currents.



CAUTION!

Only a trained electrician may connect and insert the plug-in screw terminal included in the delivery. Both solid and flexible connecting leads up to a maximum of 2.5 mm² can be used. The wire ends must be stripped over a length of 5-6 mm. The wire must not be stripped longer than 6 mm to prevent the risk of a short circuit between the conductors! A screwdriver with a 3.5 mm wide blade should be used to tighten the screws properly in the plug.



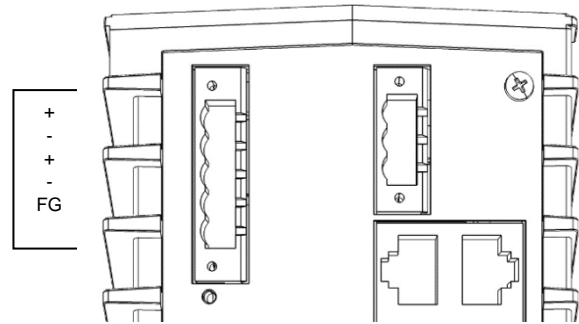
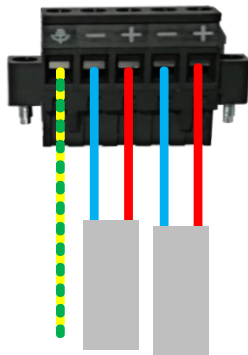

PIN ASSIGNMENT

Wiring to the 3/5-pin connector and pin assignment of the switch

Connection elements of the 3/5-pin connector

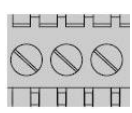

In any case please check the correct pin assignment and the correct polarity of the wiring at the supply unit.

Input DC	Diameter [mm ²]	Diameter[mm ²]	AWG	Length [mm]	Torque [Nm]
					
(+/-)+/-/FG	0.75-2.5	0.75-2.5	19-12	8	0.6-0.8

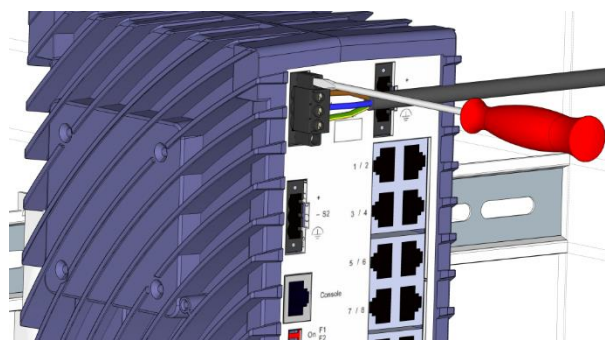

The connectors of the iGigaSwitch have screw caps. If necessary, the plug can be connected to the switch with 2 screws.

GROUNDING

Guidelines for earthing systems in connection with central power supply concepts and usage of FTTO switches for PoE applications

Examples of permissible grounding configurations.

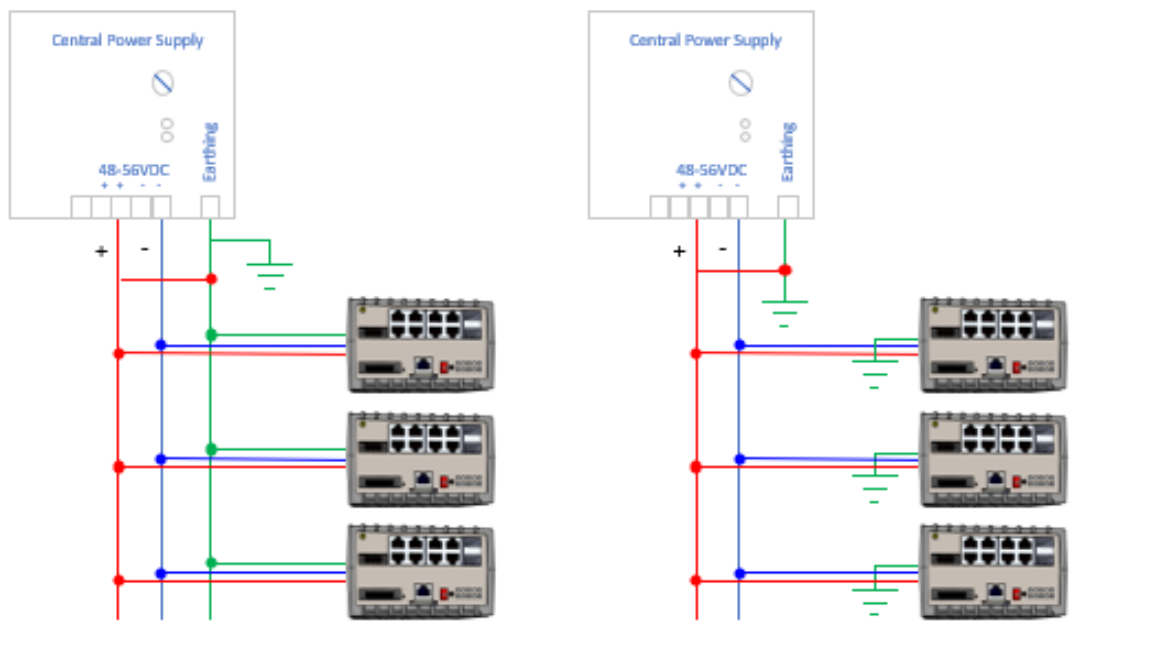

Examples of unauthorized grounding configurations. These configuration examples show the unsuitable and not allowed grounding schema, which leads to potential entanglement and short-circuit. The minus pole must never be connected to the grounding connection.

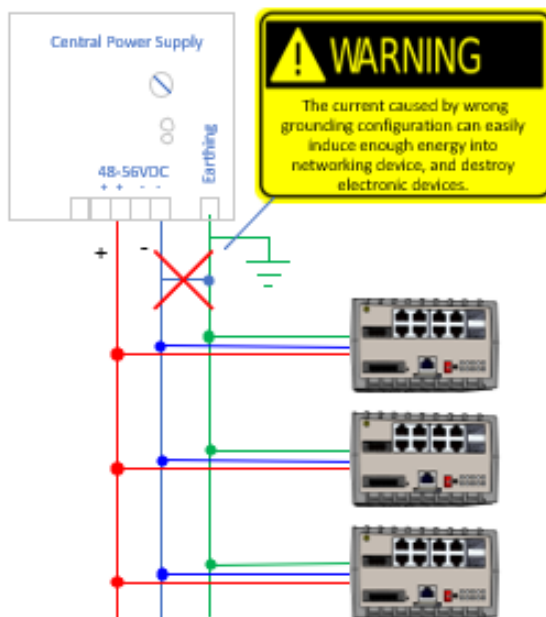

POWER OVER ETHERNET (OPTIONAL)

Power over Ethernet is an attractive and standardized alternative for the power supply of LAN equipment such as VoIP phones, Wireless LAN Access Points, IP video cameras etc., while using the "normal" Ethernet standard cable, i.e. without any additional cable tangle.

Function

An power source equipment (PSE) ensures the power supply of a powered device (PD). Nexans iGigaSwitch 10xx series supports all three different PoE standards.

- PoE IEEE802.3af
- PoE+ IEEE802.3af
- PoE++ IEEE802.3bt

For PoE and PoE+, the standard defines 3 modes of operation for power supply, which is ensured via different wire pairings of the TP data connection:

- Endpoint PSE mode A - power supply via TP pairs 1/2 and 3/6
- Endpoint PSE mode B - power supply via TP pairs 4/5 and 7/8
- Midspan PSE mode B - power supply through an external device via TP pairs 4/5 and 7/8

PoE++ is using all four pairs (1/2, 3/6, 4/5, 7/8) for power transmission. However, PoE++ is backward compatible, that means PoE or PoE+ PDs can be connected and powered.

The PoE solution will only supply power if an appropriate powered device (PD) is detected. The following functions are checked prior to enabling PoE power supply:

- The active PSE source identifies the powered device (PD).
- The operational mode is detected.
- The required power class is detected based on the classification current.

Thus, any damages can be avoided, if the connected terminal unit is not standard-compliant.



In any case please check the correct pin assignment and the correct polarity of the PoE wiring at the terminal unit.

Mode A—Pairs 1/2 and 3/6

Power Source Equipment (PSE)		Powered Device (PD)	
MDI(X)		MDI	
1 BI_DB+	PoE-	PoE+	1 BI_DA+
2 BI_DB-	PoE-	PoE+	2 BI_DA-
3 BI_DA+	PoE+	PoE-	3 BI_DB+
4 BI_DD+			4 BI_DC+
5 BI_DD-			5 BI_DC-
6 BI_DA-	PoE+	PoE-	6 BI_DB-
7 BI_DC+			7 BI_DD+
8 BI_DC-			8 BI_DD-

Power over Ethernet (optional)

Contact
 Nexans LAN Systems
 Tel.: +49 (0) 2166 27 2220
 sales.ans@nexans.com

Power Source Equipment (PSE+)

Thanks to the optional Power over Ethernet (PoE +) functionality, PoE-capable end devices can be supplied with power in accordance with IEEE 802.3at directly from the switch. The Power over Ethernet functions can be parameterized, controlled and monitored via management.

PoE class	Max. output power at PSE	Available power at PD	Classification signature	PoE standard
0	15.4 W	0.44 - 12.96 W	0 - 4 mA	IEEE 802.3af/at
1	4 W	0,44 - 3.84 W	9 - 12 mA	IEEE 802.3af/at
2	7 W	3.84 - 6.49 W	17 - 20 mA	IEEE 802.3af/at
3	15.4 W	6.49 - 12.95 W	26 - 30 mA	IEEE 802.3af/at
4	30 W	12.95 - 25.50 W	35 - 45 mA	IEEE 802.3at
5	45W	25.5 - 40W	36 - 44mA/1 - 4mA	IEEE 802.3bt
6	60W	40 - 51W	36 - 44mA/9 - 12mA	IEEE 802.3bt
7	75W	51 - 62W	36 - 44mA/17 - 20mA	IEEE 802.3bt
8	90W	62 - 71.3W	36 - 44mA/26 - 30mA	IEEE 802.3bt

Permitted voltage levels

The voltage ranges for the supply of switches are defined as follows:

PoE standard	Max. output power per port	Specified voltage range at the Power Source Equipment (PSE)	Voltage level at the switch, min. / typ. / max.
IEEE 802.3af (Type 1)	15.4W	44 - 57V DC	46 / 48 / 57V DC
IEEE 802.3at (Type 2)	30W	50 - 57V DC	50 / 54 / 57V DC
IEEE 802.3bt (Type 3)	60W	50 - 57V DC	50 / 54 / 57V DC
IEEE 802.3bt (Type 4)	90W	52 - 57V DC	50 / 54 / 57V DC

Nexans iOption combability

iOption article number	Number of PoE ports	Compatible with		
		iGigaSwitch 1002 E+ SFP-2VI	iGigaSwitch 1004 E+ SFP-4VI	iGigaSwitch 1008 E+ SFP-8VI
88301602	4x 30W	x	x	x
88301604	8x 30W	x		
88301664	4x 90W		x	
88301666	8x 90W		x	



Please check compatibility, proper pin assignment and polarity prior to and during putting the system into operation to avoid any damage resulting from attaching incompatible equipment.

The maximum load of the individual ports and the overall load are limited. These limits have to be observed in any case. Otherwise the connected units might be damaged or cannot be operated (see Technical Data).

POWER SUPPLIES



Nexans article number: 88645963

Description: iPowerSupply S 110-230VAC/24VDC 100W

Dimensions (mm): 90x90x61

Ambient temperature range (operating): -25°C to + 70°C (Derating from + 55°C)

Input voltage: 110-240V AC / 50Hz / 60Hz / 1.3A (95-250V DC)

Output voltage: 23 - 30V DC, 24V DC / 4.2 A (acc. to IEEE 802.3af and IEEE 802.3at)

Output power: max. 100 Watt

Installation: DIN rail mounting



Nexans article number: 88645960

Description: iPowerSupply S 110-230VAC/48VDC 100W

Dimensions (mm): 90x90x61

Ambient temperature range (operating): -25°C to + 70°C (Derating from + 55°C)

Input voltage: 110-240V AC / 50Hz / 60Hz / 1.3A (95-250V DC)

Output voltage: 30 - 56V DC, 54V DC / 2 A (acc. to IEEE 802.3af and IEEE 802.3at)

Output power: max. 100 Watt

Installation: DIN rail mounting



Nexans article number: 88646250

Description: iPowerSupply S 115-230VAC/48V DC 240W

Dimensions (mm): 60x130x152.5

Ambient temperature range (operating): -25°C to + 70°C (Derating from + 55°C)

Input voltage: 110-240V AC / 50Hz / 60Hz / 4.6A (95-250V DC)

Output voltage: 30 - 56V DC, 48V DC / 10 A (acc. to IEEE 802.3af and IEEE 802.3at)

Output power: max. 240 Watt

Installation: DIN rail mounting



Nexans article number: 88646072

Description: iPowerSupply S 110-230VAC/48VDC 500W

Dimensions (mm): 115x130 x153

Ambient temperature range (operating): -25°C to + 70°C (Derating from + 55°C)

Input voltage: 110-240V AC / 50Hz / 60Hz / 4.6A (95-250V DC)

Output voltage: 30 - 56V DC, 54V DC / 10 A (acc. to IEEE 802.3af and IEEE 802.3at)

Output power: max. 500 Watt

Installation: DIN rail mounting



Nexans article number: 88646182

Description: iPowerSupply S 110-230VAC 48VDC 60W

Dimensions (mm): 35x90x84

Ambient temperature range (operating): -25°C to + 70°C (Derating from + 55°C)

Input voltage: 110-240V AC / 50Hz / 60Hz / 0.67A

Output voltage: 48V DC / 1.25 A (acc. to IEEE 802.3af and IEEE 802.3at)

Output power: max. 60 Watt

Installation: DIN rail mounting

PRODUCT OVERVIEW - POWER SUPPLIES

Dimensions, Output power and voltage, installation

Nexans art.-nr.	Description	Dimensions/ Installation depth (mm)	Temperature range
88645963	iPowerSupply S 110-230VAC/24VDC 100W	90x90x61	-25...70°C
88645960	iPowerSupply S 110-230VAC/48VDC 100W	90x90x61	-25...70°C
88646250	iPowerSupply S 115-230VAC/48VDC 240W	60x130x152.5	-25...70°C
88646072	iPowerSupply S 110-230VAC/48VDC 500W	115x130x153	-25...70°C
88646182	iPowerSupply S 110-230VAC/48VDC 60W	35x90x84	-25...70°C

Nexans art.-nr.	Description	Output power	Output current
88645963	iPowerSupply S 110-230VAC/24VDC 100W	100W	24V DC
88645960	iPowerSupply S 110-230VAC/48VDC 100W	100W	30-56V DC
88646250	iPowerSupply S 115-230VAC/48VDC 240W	240W	48V DC
88646072	iPowerSupply S 110-230VAC/48VDC 500W	500W	30-56V DC
88646182	iPowerSupply S 110-230VAC/48VDC 60W	60W	48V DC

Nexans art.-nr.	Description	Installation
88645963	iPowerSupply S 110-230VAC/24VDC 100W	DIN rail mounting
88645960	iPowerSupply S 110-230VAC/48VDC 100W	DIN rail mounting
88646250	iPowerSupply S 115-230VAC/48VDC 240W	DIN rail mounting
88646072	iPowerSupply S 110-230VAC/48VDC 500W	DIN rail mounting
88646182	iPowerSupply S 110-230VAC/48VDC 60W	DIN rail mounting

TRANSMISSION PARAMETERS

Many problems occurring in data networks can be avoided. Based on many years of practical experience we can recommend the following settings for the switch systems:

Standard settings (equivalent to the default setting):

All TP ports:	Auto-Negotiation (AN)
All 100 Mbps FO ports:	100 FDX
All 1000 Mbps FO ports:	1000 FDX
PoE (PSE):	IEEE802.3at (Power over Ethernet)

These settings offer the following advantages:

- Collision-free full-duplex data transmission on fibre optic ports at maximum performance and maximum distance
 - All common TP terminal configurations are supported in a practice-oriented way
 - Auto-Negotiation: default setting of newer terminal units (automatically set to 1000 Mbps, 100 Mbps or 10 Mbps full-duplex)
- 100 Mbps-Full-Duplex: for (mostly older) terminal units having problems with auto-negotiation
- 10 Mbps-Half-Duplex: for all terminal units supporting only 10 Mbps
- PoE (PSE) feature according to IEEE802.3at is enabled by default - standard-compliant PoE (PD) terminal units or switch systems are automatically supplied with power. All other terminal units automatically receive no PoE power and are thus protected from being damaged.

Setting of connected FO switches (central, remote):

FO switch should always be set to 1000 Mbps full-duplex (FDX) or 100 Mbps (FDX) respectively. Full bandwidth and optimum performance due to non-occurrence of collisions. No length restrictions due to cable delays.

Setting of connected TP switches (central, remote):

Attached switches with TP connections should be set to auto-negotiation, just as terminal units. The automatic setting to 1000 Mbps (FDX) and 100 Mbps (FDX) also guarantees full bandwidth and maximum performance up to a line length of 100m.

MEMORY CARDS AND CONSOLE CABLES

Memory cards for switches

Nexans memory cards are redundant encrypted storage (AES256) for industrial and FTTO switches which always stores its complete and most actual configuration and firmware automatically. There are different formats: SD and micro SD for industrial and IND switches respectively.

To make network maintenance processes easier, Nexans memory cards have unique MAC address fixed on it. Switch replaces its own MAC address with the one read from memory card. In case of a switch replacement the SD card needs to be removed from one switch and installed into the new one. The MAC-address, configuration and firmware will be taken on by the new switch from this SD-card. So, no changes in the network policy or pre-setup works need to be made as the system will see same switch as before.

Nexans Part-Nr.	Description
88300692	SD Memory Card with MAC-Address
88300696	SD Memory Card with MAC integrated

Console configuration cables

The V.24 console port on Nexans switches allows you to configure the switch on site and/or retrieve its status without an Ethernet network connection. Configuration via the V.24 console port provides the same functionality as configuration via Telnet or SSH. To connect via V.24 connection to the Nexans iGigaSwitch, Nexans offers a special cable. On the host side it has an USB connector and an RJ45 at the client side.



RJ45 console cable for industrial switches

Nexans part number: 88300716

I/O MODULE

The Nexans I/O module for the iGigaSwitch series is equipped with a removable I/O connector. The outputs, digital inputs and 24V DC output are electrically isolated against each other. The status and fault diagnostics of the I/O module are monitored by the switch management.

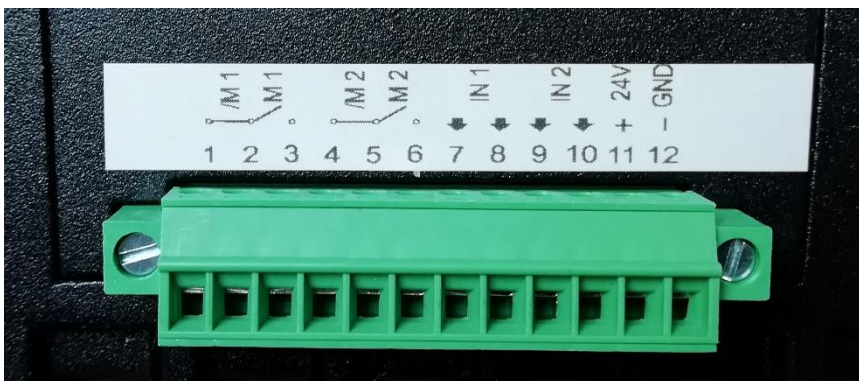

The I/O module has two relays with two contact outputs, which by default have two functions - open and closed. This allows switching of the two digital channels. The relay output module can switch 4 relay contacts. Two relays are normally open (NO) / normally closed (NC) C-type. The relay contact outputs are controlled via user-configurable setpoints through switch management. The setpoints, operating parameters and interaction can be set in the "Industrial Alarms" menu of the switch management.

The following tables show the pin connectors for I/O module board relays. The states of the relay contacts are indicated by LEDs 1 and 2 on the front of the switch (see Figure LED Indicators on page 29). If an LED is red, the contacts of the corresponding relay are activated.

Terminal No.	Signal
1	Relay No 1 normally open contact
2	Relay No 1 common PIN
3	Relay No 1 normally closed contact
4	Relay No 2 normally open contact
5	Relay No 2 common PIN
6	Relay No 2 normally closed contact

Terminal positions for terminal numbers 1...6

The digital inputs are designed to receive 12-60VDC signals polarity independent with a max. input current of 1.5mA per input. The states of the input contacts are indicated by LEDs, 1...4 (see Figure LED indicators on page 28).

Terminal No.	Signal
7	Digital Input 1 Contact No 1
8	Digital Input 1 Contact No 2
9	Digital Input 2 Contact No 1
10	Digital Input 2 Contact No 2

Input contacts – In1...In2 – I/O module contacts 7...10

The output can be used as an auxiliary voltage to power the digital inputs without the need of an external power source.

Terminal No.	Signal
11	Auxiliary voltage output power +24VDC, max. 40mA
12	Auxiliary voltage output power - (GND)

LED INDICATORS

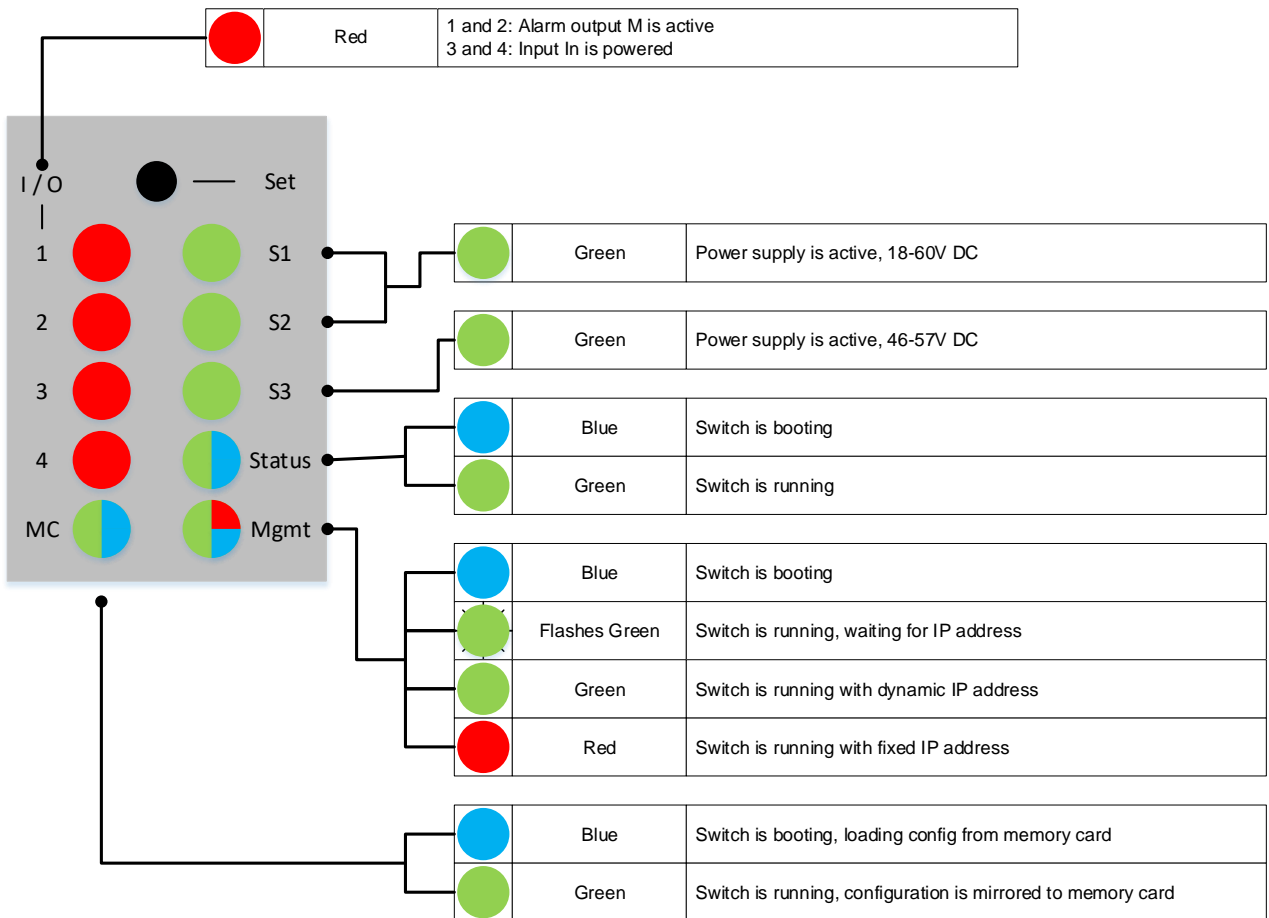

START-UP – BOOTING

Booting with Factory Default Settings

By default, the switch loads all configuration parameters stored in the flash during the boot process.

In case the customer has ordered a default customized configuration, this configuration is written to the flash during production process and is available for the very first start-up.

Nexans default configuration comes with DHCP for addressing the switch. The switch sends a DHCP request as soon as the Status-LED lights up permanently on the management module. If it receives a valid response from a DHCP server, the IP parameters are accepted, and the management module can be immediately accessed via the assigned IP address. If the switch does not get a response, the DHCP request is repeated at increasing time intervals (with a maximum interval of approx. 30 seconds).

If the switch is booted with a plugged-in MC card having a valid switch configuration, the 'MC' LED will light up in blue for some seconds during booting. When the loading of the configuration of the MC card is completed, the 'MC' LED lights up permanently in green.

CONFIGURATION MODE

i The pushbutton can be operated using a thin pin, such as a bent-open paper clip.

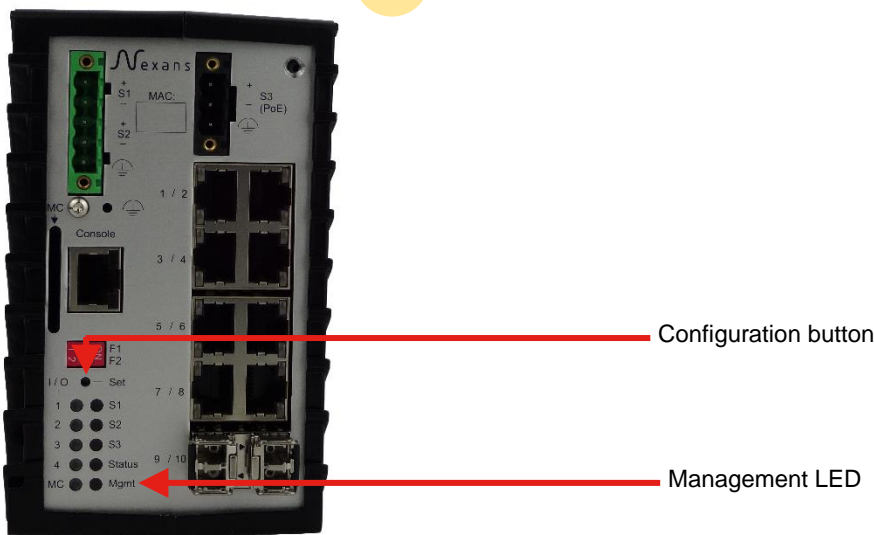

IMPORTANT NOTE: The boot functions 'Booting with fixed IP Address' and 'Booting with Factory Default Settings' can be individually disabled via the management feature to prevent an accidental or deliberate manipulation by the user.

After disabling the switch "Boot with factory default settings", a reset of the switch to factory default settings is only possible via management access.

1. Hold configuration button >3 sec.

By pressing and holding the pushbutton (min. 3 seconds) the switch will change into the configuration mode, which is indicated by the Mgmt-LED going out. As soon as the Mgmt-LED is permanently off, the pushbutton must be released. A rapidly flashing blue Mgmt-LED shows that function number 1 has been selected.

2. Briefly press configuration button

By briefly pressing the pushbutton (min. 0.1 second) the desired function can now be selected, which is indicated via the respective LED colour:

Colour	Status
Blue	Booting with flash configuration
Red	Booting with fixed IP address (172.23.44.111)
White	Booting with factory default settings
Cyan	Booting with customer default settings
Magenta	Booting without customer default settings

3. Hold configuration button >3 sec.

To execute the selected function, the pushbutton must be pressed and held for at least 3 seconds. The Status-LED flashes briefly and goes out to show that the switch has accepted the command. Now the pushbutton can be released, and the switch will boot to execute the command.



Note: The configuration mode is automatically exited, when the pushbutton is not pressed for more than 30 seconds.

Note: The functions four and five are only displayed if the respective configuration is stored.

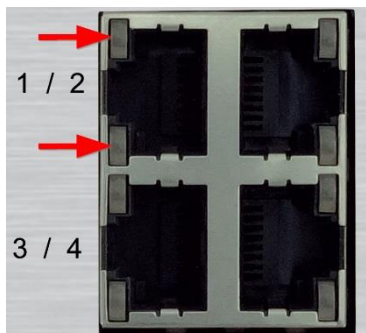

PORT STATUS LEDs



TP Links



-  Green Link signal is received at the TP interface
-  Flashes periodically Data packets are received or sent at the TP port

FDX (Transmission/speed mode detected)

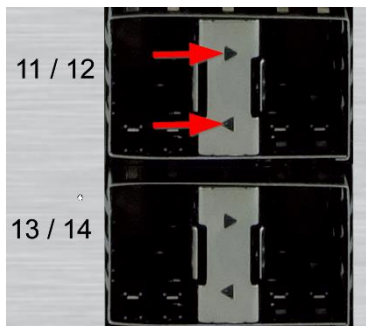
-  Flashes on-off-off-off 10 Mbps Transmission speed "Ethernet"
-  Flashes on-on-off-off 100 Mbps Transmission speed "Fast Ethernet"
-  Flashes on-on-on-off 1000 Mbps Transmission speed "Gigabit Ethernet"



SFP Links

-  Green Link signal is received at the SFP interface
-  Flashes periodically Data packets are received or sent at the SFP port

LANACTIVE MANAGER DESCRIPTION

Nexans LANactive Manager provides an easy and comfortable solution for configuration, management and supervision of Nexans Ethernet switches. Both, FTTO switches (e.g. GigaSwitch V3/V5) and switches for harsh environment (e.g. iGigaSwitch 10XX/16XX), are suitable to be managed via Nexans Device Manager.

Stand-Alone and Controller Version

LANactive Manager Stand-Alone Version is a desktop application for one or more user. The LANactive Manager Client/Controller is a client-server software architecture that allows access from different clients. The fat-client installation provides a comfortable way to manage the database without active connection to the network.

Auto Discovery

Based on the automatic discovery feature at layer 2 or layer 3, all switches part of the same subnetwork or a defined IP range will be connected and can be moved to the device list by Drag & Drop.

Master Configuration

Based on the master configuration function, one or more switches of a device list can be configured at once. With the master configuration the administrator can select which parameter shall be configured e.g. SNMP, user/admin access or VLANs. Furthermore, a master configuration can be saved for each department, in case they require different settings.

Scheduled Firmware Update

Using the time scheduled firmware update function, chosen switches can be provided with a new firmware by LANactive Manager or by itself.

Free of charge Test evaluation

Nexans LANactive Manager can be downloaded free of charge for evaluation purposes. Compared to the license-based version, the following restrictions apply:

- Delayed starting screen for registration key request
- Maximum five switches can be saved in a device list
- Fast Layer-2 and Layer-3 Auto Discovery feature for finding active switches
- Extended device list with individual sorting parameters e.g. IP address, MAC addresses, device name or software version
- Freely definable categories in tree structure
- Highlighting of switch and category by incoming alarms
- Easy to handle User-Management with different access levels, roles and user specified device lists
- Online remote diagnostic and monitoring information of SFP-modules
- Time scheduled firmware update for elected switches
- Master configuration may specify different parameters for distribution
- Creation of multiple master configurations for distribution to one or more switches
- Storage of device configurations in local or remote database
- Storage of old device configurations via history function in the database
- Extended import and export function
- Comprehensive information in system log

LANactive Manager Description

Contact
 Nexans LAN Systems
 Tel.: +49 (0) 2166 27 2220
 sales.ans@nexans.com

Device List - NEXMAN Client

Check	Device	Alarms	Redundancy	Power Consumption PoE	Input Voltage PoE	IPv4 Address	Active MAC Address	Name	Location	Description	Type	Mgmt Firmware Ver	Mgmt Hardware Ver
■	Switch 0	0 Ports (1)	Pa	4.4	54	192.168.0.3	00:CO:29:29:3A:43	Shv... Room...		GigaSwitch	74	HV15-F40-P10-OFF1	5.10
■	Switch 0	Disabled (Pa)	No	0.0	54	192.168.0.1	00:CO:29:28:D1:04	ASC... ASC		GigaSwitch	70	HV15ENHANCEDU...	3.20
■	Switch 0	0 Ports (1)	No	0.0	0	192.168.0.4	00:CO:29:25:00:88	Shv... not def.		iSwitch G.	36	HV15-F22-P10-IND...	3.04

Device Editor [ASC_Training] [192.168.0.3]

Global-Link State

Refresh interval (seconds): 1

No	Description	Name	Power Setup	Link Setup	Link State	EEE State	Link/TPP Alarm State	Time since last link change	Error Counter	Security State	Active VLAN	Active VLAN	Active VLAN Mode	Flow Control State
0	MGMT		Auto 300.3m High-Power	Autoneg	no link	no link	No alarm	No change since last reboot	0	Disabled	1	Disabled	Disabled	no link
1	TP-1	c-conen	Auto 300.3m High-Power	Autoneg	no link	no link	No alarm	No change since last reboot	0	Disabled	1	Disabled	Disabled	no link
2	TP-2	c-conen	Auto 300.3m High-Power	Autoneg	no link	no link	No alarm	No change since last reboot	0	Disabled	1	Disabled	Disabled	no link
3	TP-3	c-conen	Auto 300.3m High-Power	Autoneg	no link	no link	No alarm	No change since last reboot	0	Disabled	1	Disabled	Disabled	no link
4	TP-4	c-conen	Auto 300.3m High-Power	Autoneg	no link	no link	No alarm	0 days: 01 hours: 10 min: 16 sec	0	Disabled	1	Disabled	Disabled	ACT_ACTIVE
5	UPLINK-SFP	c-conen	Auto 300.3m High-Power	Autoneg	no link	no link	No alarm	No change since last reboot	0	Disabled	1	Disabled	Disabled	no link
6	UPLINK-TP	c-conen	Auto 300.3m High-Power	Autoneg	no link	no link	No alarm	No change since last reboot	0	Disabled	1	Disabled	Disabled	no link

Global State

Temperature (°C): 24 Internal Voltage 1 (V): 2.00 Internal Voltage 2 (V): 3.37 PoE Input Voltage (V): 24

Uptime: 0 days: 01 hours: 10 min: 25 sec Time from time server: Time Client disabled Total Boots: 13

Active MAC Address: 00:CO:29:28:D1:04 Memory Card: None inserted



FIRMWARE FEATURES

Extract

- Modular respectively On-Board high-performance management for Nexans switches
- Configuration management and archiving via Nexans LANactive Manager
- Manual and automatic firmware update via Nexans LANactive Manager
- Automatic loading of a switch configuration via DHCP/BootP option
- Automatic loading of a new firmware via DHCP/BootP and command file
- Password protection using two access levels for access via WEB, Telnet/SSH/V.24 and LANactive Manager
- Automatic IP address allocation via DHCP or fixed IP address
- Global management access protection via access list and up to 16 IP ranges
- Management Status-LED to display operating state
- Configuration is stored permanently in flash
- Display of product data such as product name, serial number, manufacturing date, temperature, etc.
- Ports can be enabled/disabled
- Autonegotiation or fixed setting of transmission parameters for each TP port
- Error counter per port for detection of incorrect duplex settings
- Support of 256 VLAN IDs in the range from 1 to 4095
- Untagged Default-VLAN can be set for each port
- Frame tagging (trunking) in accordance with IEEE802.1q selectable for each port
- Ports can simultaneously process tagged and untagged frames
- Prioritization possible for each port
- Four output queues per port for Prioritization weighting using strict or weighted fair queuing
- Bandwidth limitation can be set separately per port for Rx and Tx frames
- Portsecurity via manual definition of up to three MAC addresses per port
- Portsecurity via automatic learning of up to three MAC addresses per port
- Loop/broadcast limiter for protection against inadvertent or malicious packet storms
- Switch state display and configuration via web browser (HTTP and HTTPS)
- Password protection using two access levels (R/W or R/O) for access via web browser
- Switch state display and configuration via SNMPv1/v2/v3 and CLI (SSH, TELNET, V.24)
- Password protection using two access levels (R/W or R/O) for access via Telnet
- Eight SNMP trap and Syslog destination IP addresses selectable, each with 30 different event types
- CLI and LANactive Manager authentication via RADIUS server
- Portsecurity with authentication of the authorized MAC addresses via RADIUS server
- Portsecurity according to IEEE802.1X with authentication via RADIUS server
- Redundancy via Rapid Spanning Tree, Multiple Spanning Tree or Media Redundancy Protocol

PRODUCT LIST

iGigaSwitch 1002 E+ SFP-2VI HW5

Nexans article number: 88306422



iGigaSwitch 1002 E+ SFP-2VI; 18 - 60V DC, 46 - 57V DC for PoE; WxHxD [mm]: 83 x 133 x 125; 35mm DIN-Rail Mounting acc. to EN 60715, wall mounting; User Ports: 2x 100/1000 SFP, 8x 10/100/1000 TP; PoE: 4 or 8x 30W IEEE 802.3at (optional); WEB/Telnet/SSHv2/SNMP/ LANactive Manager, Security, RSTP/MSTP, SCP, QoS, VLANs

iGigaSwitch 1004 E+ SFP-4VI HW5

Nexans article number: 88306424



iGigaSwitch 1004 E+ SFP-4VI; 18 - 60V DC, 46 - 57V DC for PoE; WxHxD [mm]: 83 x 133 x 125; 35mm DIN-Rail Mounting acc. to EN 60715, wall mounting; User Ports: 4x 100/1000 SFP, 6x 10/100/1000 TP; PoE: 4x 30W IEEE 802.3at (optional); WEB/Telnet/SSHv2/SNMP/ LANactive Manager, Security, RSTP/MSTP, SCP, QoS, VLANs

iGigaSwitch 1008 E+ SFP-8VI HW5

Nexans article number: 88306428



iGigaSwitch 1008 E+ SFP-8VI; 18 - 60V DC, 46 - 57V DC for PoE; WxHxD [mm]: 83 x 133 x 125; 35mm DIN-Rail Mounting acc. to EN 60715, wall mounting; User Ports: 8x 100/1000 SFP, 2x 10/100/1000 TP; PoE: no support; WEB/Telnet/SSHv2/SNMP/ LANactive Manager, Security, RSTP/MSTP, SCP, QoS, VLANs



Nexans iOption

Nexans art.-nr.	Description
88301602	PoE/PoE+ option: iOption for 2/4x ports with 30W each
88301604	PoE/PoE+ option: iOption for 6/8x ports with 30W each
88301664	PoE/PoE+/PoE++ option: iOption for 2/4x ports with 90W each
88301666	PoE/PoE+/PoE++ option: iOption for 6/8x ports with 90W each

Product List

Contact

Nexans LAN Systems
Tel.: +49 (0) 2166 27 2220
sales.ans@nexans.com

iPowerSupply S 110-230VAC/24VDC 100W

Nexans article number: 88645963



iPowerSupply S; Out: 100W; 23 - 30V DC; In: 110-240V AC; WxHxD [mm]: 90x90x61; temp.r: -25...70°C; DIN rail mounting; grey

iPowerSupply S 110-230VAC/48VDC 100W

Nexans article number: 88645960



iPowerSupply S; Out: 100W; 30-56V DC; In: 114 - 240V AC; WxHxD [mm]: 90x90x61; temp.r: -25...70°C; DIN rail mounting; grey

iPowerSupply S 115-230VAC/48V DC 240W

Nexans article number: 88646250



iPowerSupply S; Out: 240W; 30-56V DC; In: 110-240V AC; WxHxD [mm]: 60x130x152.5; temp.r: -25...70°C; DIN rail mounting; grey

iPowerSupply S 110-230VAC/48VDC 500W

Nexans article number: 88646072



iPowerSupply S; Out: 500W; 30-56V DC; In: 115 - 240V AC; WxHxD [mm]: 115x130x153; temp.r: -25...70°C; DIN rail mounting; grey

iPowerSupply S 110-230VAC 48VDC 60W

Nexans article number: 88646182



iPowerSupply S; Out: 60W; 48V DC; In: 110-240V AC; WxHxD [mm]: 35x90x84; temp.r: -25...70°C; DIN rail mounting; grey



Small Form Factor Pluggable Transceiver

Nexans art.-nr.	Description
88646010	Nexans SFP 100 Transceiver GI(LC)E; Fast Ethernet; multi mode; TX/RX: 1310/1310; 2 km; LC-duplex; DDM Support; temp.r: -40°C/+85°C; dual fibre; Budget: 12 dB
88646011	Nexans SFP 100 Transceiver SM(LC)E L10; Fast Ethernet; single mode; TX/RX: 1310/1310; 10 km; LC-duplex; DDM Support; temp.r: -40°C/+85°C; dual fibre; Budget: 16 dB
88646012	Nexans SFP 100 Transceiver SM(LC)E L40; Fast Ethernet; Singlemode; TX/RX: 1310/1310; 40 km; LC-duplex; DDM Support; temp.r: -40°C/+85°C; dual fibre; Budget: 30 dB
88646013	Nexans SFP 100 Transceiver SM(LC)E L80; Fast Ethernet; Singlemode; TX/RX: 1550/1550; 80 km; LC-duplex; DDM Support; temp.r: -40°C/+85°C; dual fibre; Budget: 30 dB
88645914	Nexans SFP 100 Transceiver SF3(LC)E L10; Fast Ethernet / Single fiber BiDi Modules; Singlemode; TX/RX: 1310/1550; 10 km; LC-simplex; DDM Support; temp.r: -40°C/+85°C; single fibre; Budget: 14 dB
88645904	Nexans SFP 100 Transceiver SF5(LC)E L10; Fast Ethernet / Single fiber BiDi Modules; Singlemode; TX/RX: 1550/1310; 10 km; LC-simplex; DDM Support; temp.r: -40°C/+85°C; single fibre; Budget: 14 dB
88646113	Nexans SFP 100 Transceiver SF3(LC)E L40; Fast Ethernet / Single fiber BiDi Modules; Singlemode; TX/RX: 1310/1550; 40 km; LC-simplex; DDM Support; temp.r: -40°C/+85°C; single fibre; Budget: 30 dB
88646115	Nexans SFP 100 Transceiver SF5(LC)E L40; Fast Ethernet / Single fiber BiDi Modules; Singlemode; TX/RX: 1550/1310; 40 km; LC-simplex; DDM Support; temp.r: -40°C/+85°C; single fibre; Budget: 30 dB
88645915	Nexans SFP 100 Transceiver SF3(SC)E L40; Fast Ethernet / Single fiber BiDi Modules; Singlemode; TX/RX: 1310/1550; 40 km; SC-simplex; DDM Support; temp.r: -40°C/+85°C; single fibre; Budget: 30 dB
88645916	Nexans SFP 100 Transceiver SF5(SC)E L40; Fast Ethernet / Single fiber BiDi Modules; Singlemode; TX/RX: 1550/1310; 40 km; SC-simplex; DDM Support; temp.r: -40°C/+85°C; single fibre; Budget: 30 dB
88646015	Nexans SFP 1000 Transceiver GI(LC)E; Gigabit Ethernet; Multimode; TX/RX: 850/850; 550 m; LC-duplex; DDM Support; temp.r: -20°C/+85°C; dual fibre; Budget: 9 dB
88646016	Nexans SFP 1000 Transceiver SM(LC)E L10; Gigabit Ethernet; Singlemode; TX/RX: 1310/1310; 10 km; LC-duplex; DDM Support; temp.r: -40°C/+85°C; dual fibre; Budget: 12 dB
88646017	Nexans SFP 1000 Transceiver SM(LC)E L40; Gigabit Ethernet; Singlemode; TX/RX: 1310/1310; 40 km; LC-duplex; DDM Support; temp.r: -40°C/+85°C; dual fibre; Budget: 19 dB
88646018	Nexans SFP 1000 Transceiver SM(LC)E L80; Gigabit Ethernet; Singlemode; TX/RX: 1550/1550; 80 km; LC-duplex; DDM Support; temp.r: -40°C/+85°C; dual fibre; Budget: 24 dB
88646019	Nexans SFP 1000 Transceiver SM(LC)E L120; Gigabit Ethernet; Singlemode; TX/RX: 1550/1550; 120 km; LC-duplex; DDM Support; temp.r: -40°C/+85°C; dual fibre; Budget: 29 dB
88646073	Nexans SFP 1000 Transceiver SF3(LC)E L10; Gigabit Ethernet / Single fiber BiDi Modules; Singlemode; TX/RX: 1310/1550; 10 km; LC-simplex; DDM Support; temp.r: -40°C/+85°C; single fibre; Budget: 12 dB
88646075	Nexans SFP 1000 Transceiver SF5(LC)E L10; Gigabit Ethernet / Single fiber BiDi Modules; Singlemode; TX/RX: 1550/1310; 10 km; LC-simplex; DDM Support; temp.r: -40°C/+85°C; single fibre; Budget: 12 dB
88646133	Nexans SFP 1000 Transceiver SF3(LC)E L40; Gigabit Ethernet / Single fiber BiDi Modules; Singlemode; TX/RX: 1310/1550; 40 km; LC-simplex; DDM Support; temp.r: -40°C/+85°C; single fibre; Budget: 19 dB
88646135	Nexans SFP 1000 Transceiver SF5(LC)E L40; Gigabit Ethernet / Single fiber BiDi Modules; Singlemode; TX/RX: 1550/1310; 40 km; LC-simplex; DDM Support; temp.r: -40°C/+85°C; single fibre; Budget: 19 dB



Cable sets and connectors

Nexans art.-nr.	Description
88646144	Junction box black class II 3 wires
88646169	RJ45 serial cable for Industrial Switch
88300716	RJ45 to USB adapter for serial console
N205.617	Nexans LANmark-OF Duplex LC Snap-In Adaptor Multimode Aqua
N205.627	Nexans LANmark-OF Duplex LC Snap-In Adaptor Singlemode
N205.628	Nexans LANmark-OF Duplex LC Snap-In Adaptor Singlemode APC
N420.555	Nexans LANmark-5 Evo Snap-In Connector Cat 5e Screened
N420.556	Nexans LANmark-5 Evo Snap-In Connector Cat 5e Screened Stranded Wire
N420.666	Nexans LANmark-6 Evo Snap-In Connector Cat 6 Screened
N420.667	Nexans LANmark-6 Evo Snap-In Connector Cat 6 Screened Stranded Wire
N420.66A	Nexans LANmark-6A Evo Snap-In Connector Cat 6A Screened
N420.67A	Nexans LANmark-6A Evo Snap-In Connector Cat 6A Screened Stranded Wire
N420.735	Nexans LANmark-7A GG45 12C Snap-In Connector Cat 7A Screened
N42m.730	Nexans LANmark Maritime GG45 Marine Snap-In Connector Cat 7A Screened



Memory Cards

Nexans art.-nr.	Description
88300692	SD Memory Card with MAC-Address
88300696	SD Memory Card with MAC integrated

Support Nexans Support-Packages

Nexans art.-nr.	Description
88642010	Support-Package "Engage" - Third Level Support
88642011	Support-Package "Getting Started" - Third Level Support
88643001	Enhanced Network Management Training



Installation accessories

Nexans art.-nr.	Description
88646039	19" DIN-Rail Mounting Kit, 3 HU,49x132x20
88646260	Starter Kit Case LANActive Industry
N42i.101	Nexans LANmark Industry Modular iConnect Box DIN Rail Mount 6 Snap-In Black
N42i.105	Nexans extension for LANmark Industry Modular iConnect Box DIN Rail Mount 6 Snap-In Black
N42i.106	Nexans LANmark Industry iConnect Splice Cassette 12x heat shrink protection
N42i.102	Nexans LANmark Industry iConnectBox Splice Cassette 6x splice protection holder
N42i.104	Nexans LANmark Industry iConnect Splice Cassette Cover Grey
N20i.000	Nexans LANmark Industry DIN-rail mount module with 1x Snap-In Cat 6 Grey 12x
N20i.004	Nexans LANmark Industry DIN-rail mount module with 1x Snap-In Cat 6A Grey 12x
N20i.005	Nexans LANmark Industry DIN-rail mount module with 1x Snap-In Cat 7A Grey 12x
N20i.002	Nexans LANmark Industry Side Cover DIN-rail mount Cat 6 Grey
N20i.003	Nexans LANmark Industry Side Cover DIN-rail mount Cat 7 Grey



Nexans LANActive Manager

Nexans art.-nr.	Description
88301908	LANActive Manager Single User Licence
88301909	LANActive Manager Company Licence
88301920	LANActive Manager Controller Licence
Nexans device manager can be downloaded free of charge for evaluation purposes (max. five switches in device list and delayed starting screen) at www.nexans-ans.de/support/	

SUPPORT PORTAL

Important notes for switches with Management Hardware HW5

This manual is about the latest generation of V5 switches with **management hardware HW5** (e.g. GigaSwitch V5 or iGigaSwitch 10xx/16XX). Nexans strongly recommends downloading and installing the latest Switch Firmware Version. This ensures that you get all the new features and bug fixes.

In addition to the new firmware, the current version of the Nexans LANactive Manager must be installed to manage switches with Management Hardware HW5. This manager version is also backward compatible with switches using Management Hardware HW3, HW2 and HW1. The current version of LANactive Manager also includes the configuration options for all new firmware features.

If you are not yet a registered user of the Nexans Support Portal, please register at the Nexans support portal <http://www.nexans-ans.de/support/> and download the latest version of the firmware and the management tool. Here you will also find the related release notes and the current versions of management manual.

If you have any questions or problems, please contact us at the following support e-mail address: support.ans@nexans.com

To benefit from individualized and extended product support, we recommend concluding a Nexans support contract.

If you are interested, please send us your request by e-mail to sales.ans@nexans.com



Please visit our support portal under:

www.nexans-ans.de/support

At our support portal, you'll find the latest information and downloads of the following points:

- Documentation
- Installation instructions
- Starter Kits
- Quick Start
- Release Notes
- Nexans LANactive Manager
- Firmware Images
- SNMP MIBs
- RMA Request
- Frequently Asked Questions (FAQs)

Nexans Advanced Networking Solutions GmbH
Support Team
Phone: +49 (0) 2166 27-2017
E-Mail: support.ans@nexans.com
Sales Team / RMA Service
Phone: +49 (0) 2166 27-2220
E-Mail: sales.ans@nexans.com

LANACTIVE STARTER KITS

Demo kits with FTTO switches

LANactive Starter Kits are designed to demonstrate Nexans managed FTTO and Industrial Ethernet switches capabilities by professional way. It can be used during the technical evaluation, meetings, exhibitions or provided to the customers for further testing.



The **LANactive V5 FTTO Starter Kit** provides the easiest method to experience management and integration with FTTO components. Combined with LANactive Manager evaluation software version, this kit gets your project running quickly. All required components: GigaSwitch V5, SFP modules, installation material and connection cables are in the scope of delivery.

The **LANactive Industry Starter Kit** includes one managed Industrial Ethernet switch from Nexans iGigaSwitch family with PoE+ and I/O functionality as well as several accessories: industrial power supply, SFP transceivers, memory card and serial cable. All components are fully functional and ready to operate. The starter kit case has the slots for other optional cabling components from LANactive Industry solution - DIN-rail mounted universal iConnectBox patch panel, industrial RJ45 plug for field termination, copper and fibre patch cords.



For more information about the Nexans Starter Kits visit:

www.nexans.com/LANactiveStarterKit



Nexans Starter Kits

Nexans art.-nr.	Description
88353910	<p>Starter Kit GSW V5 TP(PSE+) SFP-2VI PoE 1x88303910 GigaSwitch V5 TP(PSE+) SFP-2VI 54VDC; 1x 88646240 Click-In Power Supply 54V DC/130W 135x45, RAL9010; 1x88646300 FTTO cable duct Starter Kit set 2L; 1x88300691 Memory Card for Office Switch with MAC address; 1x88646264 PSU Cable Set 54VDC 1m 230VAC 1.5m WLND; 1x88645985 Cable Schuko + Wieland 2m GST1813K1BD 15; 1x88646030 Cover set 45x90 incl. MR, WH/9010, 80x150; 1x88646016 Nexans SFP 1000 Transceiver SM(LC)E, singlemode 1310nm, 10km; 1x88646015 Nexans SFP 1000 Transceiver GI(LC)E, Gbit, multimode 850nm, 550m; 1x88646029 FO adaption kit LC-DX to ST, 0,5m, incl. 2xST adaptors; 1x88645932 SC-DX/ST GI (multimode) adaptor for SC to ST adaptor</p>
88353955	<p>Starter Kit GSW V5 TP SFP-VI PoE+ 1x88303955 GigaSwitch V5 TP SFP-VI 48/54VDC; 1x 88646200 Click-In Power Supply 54V DC/70W 90x45, RAL9010; 1x88646300 FTTO cable duct Starter Kit set 2L; 1x88300691 Memory Card for Office Switch with MAC address; 1x88646264 PSU Cable Set 54VDC 1m 230VAC 1.5m WLND; 1x88645985 Cable Schuko + Wieland 2m GST1813K1BD 15; 1x88646030 Cover set 45x90 incl. MR, WH/9010, 80x150; 1x88646016 Nexans SFP 1000 Transceiver SM(LC)E, singlemode 1310nm, 10km; 1x88646015 Nexans SFP 1000 Transceiver GI(LC)E, Gbit, multimode 850nm, 550m; 1x88646029 FO adaption kit LC-DX to ST, 0,5m, incl. 2xST adaptors; 1x88645932 SC-DX/ST GI (multimode) adaptor for SC to ST adaptor</p>
88353953	<p>Starter Kit GSW V5 SFP-2VI PoE+ 1x88303953 GigaSwitch V5 SFP-2VI 48/54VDC; 1x 88646200 Click-In Power Supply 54V DC/70W 90x45, RAL9010; 1x88646300 FTTO cable duct Starter Kit set 2L; 1x88300691 Memory Card for Office Switch with MAC address; 1x88646264 PSU Cable Set 54VDC 1m 230VAC 1.5m WLND; 1x88645985 Cable Schuko + Wieland 2m GST1813K1BD 15; 1x88646030 Cover set 45x90 incl. MR, WH/9010, 80x150; 1x88646016 Nexans SFP 1000 Transceiver SM(LC)E, singlemode 1310nm, 10km; 1x88646015 Nexans SFP 1000 Transceiver GI(LC)E, Gbit, multimode 850nm, 550m; 1x88646029 FO adaption kit LC-DX to ST, 0,5m, incl. 2xST adaptors; 1x88645932 SC-DX/ST GI (multimode) adaptor for SC to ST adaptor</p>
88353975	<p>Starter Kit GSW V5 TP SFP-VI 230VAC 1x88303975 GigaSwitch V5 TP SFP-VI 230VAC; 1x88646305 FTTO cable duct Starter Kit set 1L; 1x88300691 Memory Card for Office Switch with MAC address; 1x88301071 230V cable KKM Type III - GST18i3; 1x88645985 Cable Schuko + Wieland 2m GST1813K1BD 15; 1x88646030 Cover set 45x90 incl. MR, WH/9010, 80x150; 1x88646016 Nexans SFP 1000 Transceiver SM(LC)E, singlemode 1310nm, 10km; 1x88646015 Nexans SFP 1000 Transceiver GI(LC)E, Gbit, multimode 850nm, 550m; 1x88646029 FO adaption kit LC-DX to ST, 0,5m, incl. 2xST adaptors; 1x88645932 SC-DX/ST GI (multimode) adaptor for SC to ST adaptor</p>
88353652	<p>Starter Kit GSW 641 Desk V5 SFP-VI POE+ 1x88303652 GigaSwitch 641 Desk V5 SFP-VI; 1x88646077 Power Supply with Schuko 54VDC/65W; 1x88300691 Memory Card for Office Switch with MAC address; 1x88646084 Mounting Kit GigaSwitch Desk RAL9010; 1x88646016 Nexans SFP 1000 Transceiver SM(LC)E, singlemode 1310nm, 10km; 1x88646015 Nexans SFP 1000 Transceiver GI(LC)E, Gbit, multimode 850nm, 550m; 1x88646029 FO adaption kit LC-DX to ST, 0,5m, incl. 2xST adaptors; 1x88645932 SC-DX/ST GI (multimode) adaptor for SC to ST adaptor</p>



Nexans Starter Kits

Nexans art.-nr.	Description
88353658	<p>Starter Kit GSW V5 TP SFP-VI 230VAC MED 1x88303658 GigaSwitch V5 TP SFP-VI 230VAC MED; 1x88646305 FTTO cable duct Starter Kit set 1L; 1x88300691 Memory Card for Office Switch with MAC address; 1x88301071 230V cable KKM Type III - GST18i3; 1x88645985 Cable Schuko + Wieland 2m GST18i3K1BD 15; 1x88646030 Cover set 45x90 incl. MR, WH/9010, 80x150; 1x88646016 Nexans SFP 1000 Transceiver SM(LC)E, singlemode 1310nm, 10km; 1x88646015 Nexans SFP 1000 Transceiver GI(LC)E, Gbit, multimode 850nm, 550m; 1x88646029 FO adaption kit LC-DX to ST, 0,5m, incl. 2xST adaptors; 1x88645932 SC-DX/ST GI (multimode) adaptor for SC to ST adaptor</p>
88353602	<p>Starter Kit GSW V5 TP(PDF) SFP-VI 54V MED 1x88303602 GigaSwitch V5 TP(PD-F) SFP-VI 48/54V MED; 1x88646305 FTTO cable duct Starter Kit set 1L; 1x88300691 Memory Card for Office Switch with MAC address; 1x88646030 Cover set 45x90 incl. MR, WH/9010, 80x150; 1x88646016 Nexans SFP 1000 Transceiver SM(LC)E, singlemode 1310nm, 10km; 1x88646015 Nexans SFP 1000 Transceiver GI(LC)E, Gbit, multimode 850nm, 550m; 1x88646029 FO adaption kit LC-DX to ST, 0,5m, incl. 2xST adaptors; 1x88645932 SC-DX/ST GI (multimode) adaptor for SC to ST adaptor</p>
88356400	<p>Starter Kit iGSW 1604 SFP-4VI I/O PoE+ 1x88306400 iGigaSwitch 1604 E+ SFP-4VI PRO3; 1x 88645960 iPowerSupply S 110-230VAC/48VDC 100W; 1x88646260 Starter Kit Case LANactive Industry; 1x88301606 iOption PoE Typ at 12-30; 1x88301600 iSwitch I/O Module Digital 4xIn 2xOut; 1x88300692 SD Memory Card for i-Series with MAC-Address; 2x88646015 Nexans SFP 1000 Transceiver GI(LC)E, Gbps, multi mode, 850nm, 550m; 2x88646016 Nexans SFP 1000 Transceiver SM(LC)E L10, Gbps, single mode, 10km; 1x88646169 RJ45 serial cable for Industrial Switch; 1x88646029 FO adaption kit LC-DX to ST, 0,5m, incl. 2xST adaptors; 1x88645932 SC-DX/ST GI (multimode) adaptor for SC to ST adaptor</p>
88356422	<p>Starter Kit iGSW 1002 SFP-2VI I/O PoE+ 1x88306422 iGigaSwitch 1002 E+ SFP-2VI; 1x 88645960 iPowerSupply S 110-230VAC/48VDC 100W; 1x88646260 Starter Kit Case LANactive Industry; 1x88301604 iOption PoE Typ at 08-30; 1x88300692 SD Memory Card for i-Series with MAC-Address; 2x88646015 Nexans SFP 1000 Transceiver GI(LC)E, Gbps, multi mode, 850nm, 550m; 2x88646016 Nexans SFP 1000 Transceiver SM(LC)E L10, Gbps, single mode, 10km; 1x88646169 RJ45 serial cable for Industrial Switch; 1x88646029 FO adaption kit LC-DX to ST, 0,5m, incl. 2xST adaptors; 1x88645932 SC-DX/ST GI (multimode) adaptor for SC to ST adaptor</p>
88356406	<p>Starter Kit iGSW 1606 HSR SFP-6VI HW5 1x88306406 iGigaSwitch 1606 HSR SFP-6VI; 1x 88645960 iPowerSupply S 110-230VAC/48VDC 100W; 1x88646260 Starter Kit Case LANactive Industry; 1x88301604 iOption PoE Typ at 08-30; 1x88301600 iSwitch I/O Module Digital 4xIn 2xOut; 1x88300692 SD Memory Card for i-Series with MAC-Address; 2x88646015 Nexans SFP 1000 Transceiver GI(LC)E, Gbps, multi mode, 850nm, 550m; 2x88646016 Nexans SFP 1000 Transceiver SM(LC)E L10, Gbps, single mode, 10km; 1x88646169 RJ45 serial cable for Industrial Switch; 1x88646029 FO adaption kit LC-DX to ST, 0,5m, incl. 2xST adaptors; 1x88645932 SC-DX/ST GI (multimode) adaptor for SC to ST adaptor</p>

FREQUENTLY ASKED QUESTIONS (FAQ)

Where are these systems typically used?

Basically, the cabling infrastructures in buildings are strongly affected by technology changes. Approximately every 5 years the network data rates are increasing by a factor of 10. Therefore, a future proof network infrastructure is indispensable to ensure an investment protection. A continuous "FTTO - Fibre To The Office" cabling infrastructure is an optimum solution.

How can the configuration be transferred to the new system after a possible system failure?

The Nexans systems provide a unique concept for the recovery of the complete system configuration. This allows untrained staff to easily reconfigure the system after a failure. All Switch systems are equipped with an integrated memory card slot through which the complete system configuration may be saved as a backup copy. In the event of a failure, the user only needs to swap out the memory card from the old switch, insert it into the new switch, and the configuration will automatically be mirrored to the new device. The switch can be booted with the MAC address of the memory card, so the superior address tables (e.g. in routers) all remain unaffected.

How is the conversion from fibre to copper realized?

By using Nexans GigaSwitch Systems a standard complying conversion from fibre to copper can be realized easily. The systems are designed for an installation in cable ducts or floor boxes. They have got up to 2 uplink interfaces on the reverse side and four twisted pair user interfaces on the front side.

Do the systems require a power supply?

Active systems with PoE capability always require an external power supply. The Nexans GigaSwitch Systems can be operated with a centralized or decentralized 48VDC power supply. This 48 VDC power supply can also be used to supply the connected Power over Ethernet terminal equipment simultaneously. Thanks to the implemented Power-over-Ethernet (PoE)-Functionalities e.g. VoIP-Phones, Wireless-Access-Points and IP-Cameras can be supplied with power from the switch system directly. External power supplies for the connected terminal equipment are no longer needed.

Can IP cams or wireless access points and similar devices be powered via the switch?

Power Source Equipment (PSE)

The implemented manageable Power over-Ethernet (PoE) feature makes it further possible to power e.g. IP cameras, wireless access points, VoIP phones or multifunctional terminals directly via the switch system. Thereby, the user does not need any plugin power supplies for the terminal units.

What if the backbone data rate changes?

Investment Protection

The Nexans Systems are offering a very high level of investment protection. The SFP uplink interface of the GigaSwitch system can be equipped with a Fast Ethernet SFP or a Gigabit SFP module. In case of a data rate change from 100 Mbps to 1000 Mbps you only must change the SFP transceiver module. A system exchange is not necessary!

How can the initial configuration be performed?

To ensure simple configuration and management of these devices, Nexans has designed an easy to use tool specifically tailored to the requirements of the user. The Nexans LANactive Manager ensures the automated distribution of master configurations and software updates to any number of industrial switches. Distribution of the complete or partial configuration is all possible. Another important feature of LANactive Manager is the central archiving of all switch configurations in a database. In case of failure, this key feature will ensure the rapid reconfiguration of the switch parameters and minimize downtime.

How can the systems be monitored?

LANactive Manager

The LANactive Manager user interface provides the administrator with a complete overview of the current state and accessibility of the switch systems available in the network. By simply selecting a switch system, you can set several parameters such as port configuration, SNMP trap receiver, 802.1x, Radius, and many more. The user does not need to have knowledge of complex management software systems to perform this function.

What management interfaces are supported?

WEB, TELNET, SSH and SNMP management interfaces are also supported. The integration into higher management systems like HP OpenView, Spectrum, etc. is further made possible.

Is the early detection of changes on the optical link possible?

A multitude of parameters can be read out from systems with SFP interface via the management system. Changes in the link characteristics (e.g. attenuation increases) can be detected and resolved based on threshold values prior to a possible total failure of the link. Appropriate messages (SNMP traps, Syslog) can also be sent to a central management system.

How do you prevent unauthorized access to network?

Nexans switch systems support all relevant security mechanisms such as IEEE802.1x and MAC-based access control. In connection with a central authentication server, e.g. RADIUS, security in enterprise networks is considerably improved. Maximum security is achieved by access control directly at the user port of the Nexans switch system. Thus, the identity of the client is verified directly at the connection point and not only at the bundled port of the central switch. Any potential abuse of the network connection, e.g. by listening in on traffic, is thus principally excluded.

What happens in case of a link failure?

All switch systems support the Rapid Spanning Tree Protocol (RSTP). The RSTP guarantees the automatic and fast switchover to a redundant link in the event of the failure of a transmission link. This feature clearly improves the availability of the network!

ABBREVIATIONS

A

A	Ampere
ACL	Access Control List
AN	Auto-Negotiation
ARP	Address Resolution Protocol

B

BiDi	Bidirectional
BootP	Bootstrap Protocol

C

CE	Communauté Européenne
CEN	Comité Européen de Normalisation
CENELEC	Comité Européen de Normalisation en Electrotechnique

CDP	Cisco Discovery Protocol
-----	--------------------------

CLI	Call Level Interface
-----	----------------------

CSV	Comma-seperated Values
-----	------------------------

D

dB	Decibel
DHCP	Dynamic Host Configuration Protocol
DIN	Deutsches Institut für Normung
DDM(I)	Digital Diagnostic Monitoring (Interface)

E

ECG	Electrocardiogram
EN	European Norm
ETSI	European Telecommunications Standard Institute

F

FDX	Full Duplex
FO	Fibre Optic
FTTO	Fibre To The Office

G

g	Gram
GI	Graded Index

H

HDX	Half Duplex
HTTP	Hypertext Transfer Protocol
HTTPS	Hypertext Transfer Protocol Secure

I

IGMP	Internet Group Management Protocol
------	---------------------------------------

IEC	International Electrotechnical Commission
-----	----------------------------------------------

IEEE	Institute of Electrical and Electronics Engineers
------	------------------------------------------------------

IP	International Protection (or Ingress Protection)
----	-----------------------------------------------------

IT	Information Technology
----	------------------------

L

LACP	Link Aggregation Control Protocol
------	--------------------------------------

LLDP	Link Layer Discovery Protocol
------	-------------------------------

M

MAC	Media Access Control
-----	----------------------

Mbps	Megabit per second
------	--------------------

MDI	Medium Dependent Interface
-----	----------------------------

MD5	Message-Digest Algorithm 5
-----	----------------------------

MIB	Management Information Base
-----	-----------------------------

MM	Multimode
----	-----------

MSTP	Multiple Spanning Tree Protocol
------	---------------------------------

MTBF	Mean Time Between Failures
------	----------------------------

P

PD	Powered Device
----	----------------

PD-F	Powered Device Forwarding
------	---------------------------

PE	Protective Earth
----	------------------

PoE	Power over Ethernet
-----	---------------------

PSE	Power Source Equipment
-----	------------------------

Q

QinQ	VLAN double tagging
------	---------------------

QoS	Quality of Service
-----	--------------------

R

RADIUS	Remote Authentication Dial-In User Service
--------	-----------------------------------------------

RJ	Registered Jack
----	-----------------

RMON	Remote Monitoring
------	-------------------

RSTP	Rapid Spanning Tree Protocol
------	------------------------------

Abbreviations

Contact

Nexans LAN Systems
Tel.: +49 (0) 2166 27 2220
sales.ans@nexans.com

RX	Receiver
S	
s	Second
SCP	Secure Copy Protocol
SELV	Safety Extra Low Voltage
SFP	Small Form-factor Pluggable
SM	Singlemode
SNMP	Simple Network Management Protocol
SNTP	Simple Network Time Protocol
SQL	Structured Query Language
SSH	Secure Shell
T	
TCP	Transmission Control Protocol
Telnet	Telecommunication Network
Temp.r.	Temperature range
TFTP	Trivial File Transfer Protocol
TP	Twisted Pair
TX	Transmitter
V	
V	Volt
VAC	Volt alternating current
VDC	Volt direct current
VLAN	Virtual Local Area Network
W	
W	Watt
WxHxD	Width x height x dept

OFFICES

Nexans Cabling Solutions

Alsebergsesteenweg 2, b3

B-1501 Buizingen

Belgium

Tel: +32 (0)2 363 38 00

Fax: +32 (0)2 365 09 99

Advanced Networking Solutions

Bonnenbroicher Str. 2-14

41238 Monchengladbach

Germany

Tel: +49 2166 27-2220

Fax: +49 2166 27-2499